



SCIENCE FEST

HV101



PRODUCT INFORMATION

Product Line	●	Digital
User Ages	●	3-12
User Capacity	●	17
Fall Height	●	150cm
Dimension	●	563cm x 629cm
Safety Area	●	99m ²
Safety Dimension	●	963cm x 1029cm
Maximum Height	●	385cm
Weight	●	kg
Safety Certificate	●	EN 1176-3



PRODUCT DESCRIPTION

The Science Fest series is a fun world of science and technology designed for curious minds to explore. It showcases various scientific figures, images, and topics, supporting children's learning while having fun.

The aim is to provide an ideal play area that reinforces the exploration passion of little scientists.

ACTIVITIES



Sliding



Climbing



Running



Sitting



Role Play



Thinking



Hand Skill



Socializing

Address: Yukarı Eğercili Mahallesi, Atatürk Bulvarı, No:122 Çarşamba/SAMSUN Post Code: 55500

Tel: +90 362 266 66 96 polfisan@polfisan.com.tr www.polfisan.com.tr



Made in Türkiye



SCIENCE FEST

HV101



PRODUCT SPECIFICATION



Number of Users
•
17



Number of Roofs
•
1



Number of Slides
•
2



Number of Entrances
•
4

COLOR PALETTE



MATERIAL SPECIFICATION

- Main construction is made of steel pipes, diameter 89mm and thickness 3mm.
- Platforms are made of 18mm plywood.
- Roof, railings and panels are made of HPL (High Pressure Laminate) and UV-protected Polycarbonate panels, which are resistant to all weather conditions.
- It is produced using digital printing with high-quality UV curing inks that are resistant to all weather conditions.
- Slide surface is high-strength HDPE material with 15mm thickness. Slide walls are made of HPL.
- Tube slide is made of medium-density polyethylene material in a tunnel shape and transparent polycarbonate.
- Rope is made of polypropylene braided steel rope, diameter 16mm with 6 steel rope helices.
- Pipe and profile openings are covered with plastic injection caps.
- The metal surfaces of the product have been cleaned by sandblasting, washing, rinsing, and drying; zinc primer has been applied to increase corrosion resistance, and it has been painted with electrostatic powder coating.
- Screws are covered with plastic caps.
- Product doesn't have sharp edges and surfaces.
- Product has been produced in accordance with EN1176 standards.
- Please contact to Polfisan for updated information about product.

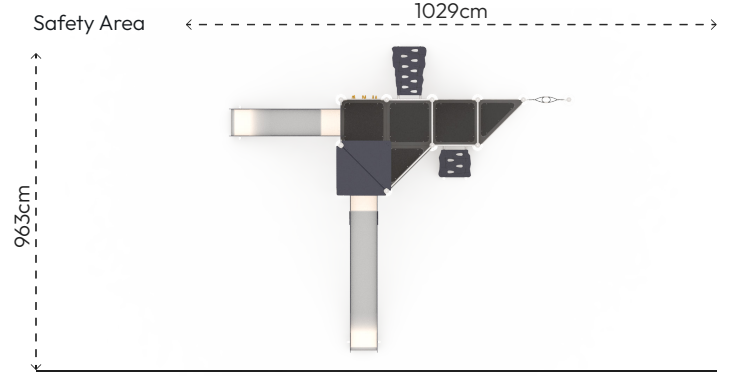

Top View

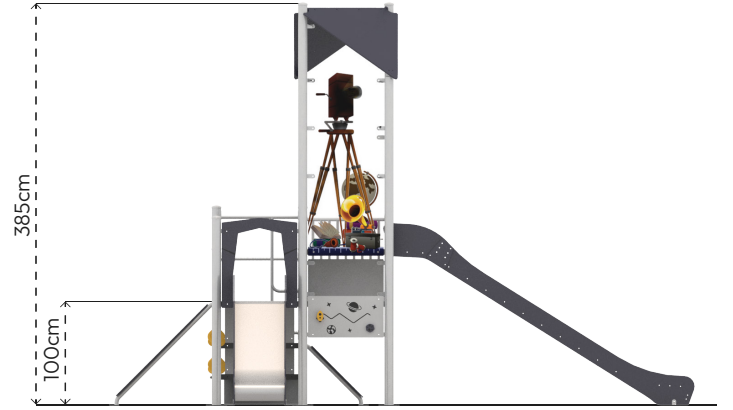

Side View

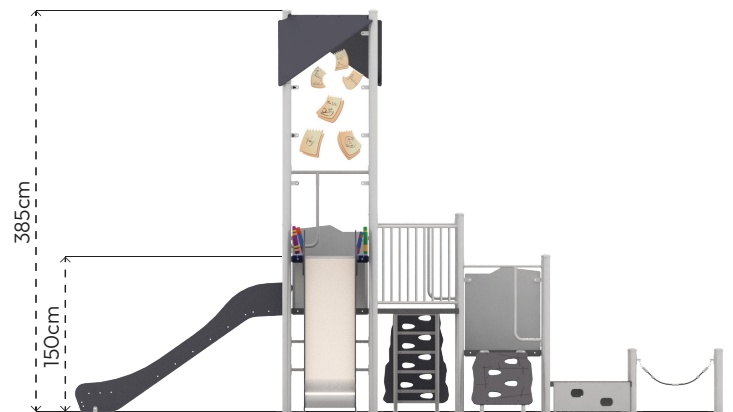

Front View

